



**Instructions for the following
series products:**

Talon SRLs

(See back pages for specific
model numbers.)

**USER INSTRUCTION MANUAL
TALON™ SELF RETRACTING LIFELINES**

This manual is intended to meet the Manufacturer's Instructions as required by ANSI Z359.1 and should be used as part of an employee training program as required by OSHA.

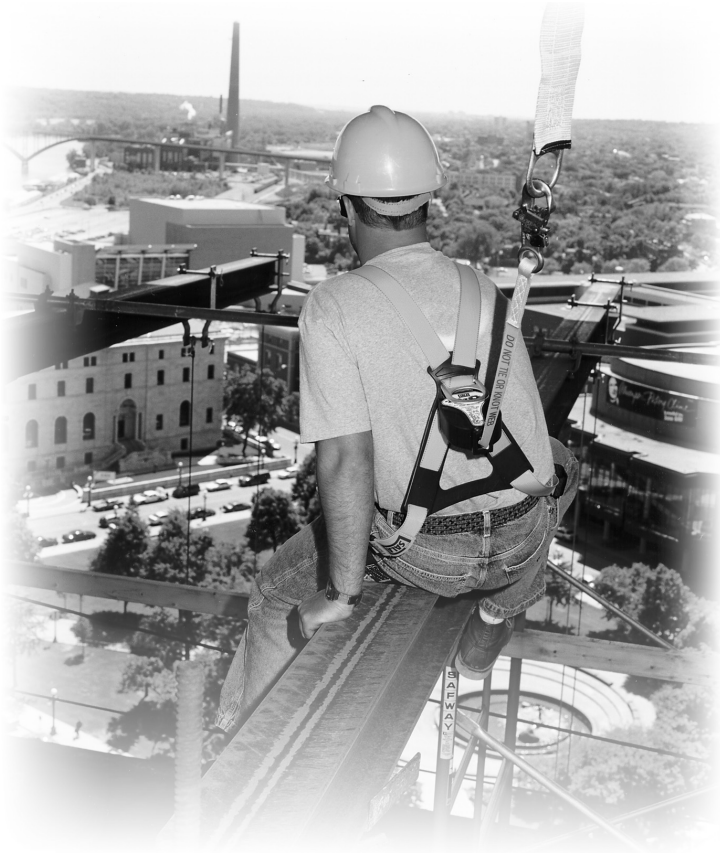

Figure 1 - Talon Self Retracting Lifeline - 8 ft. (2.4 m) Series

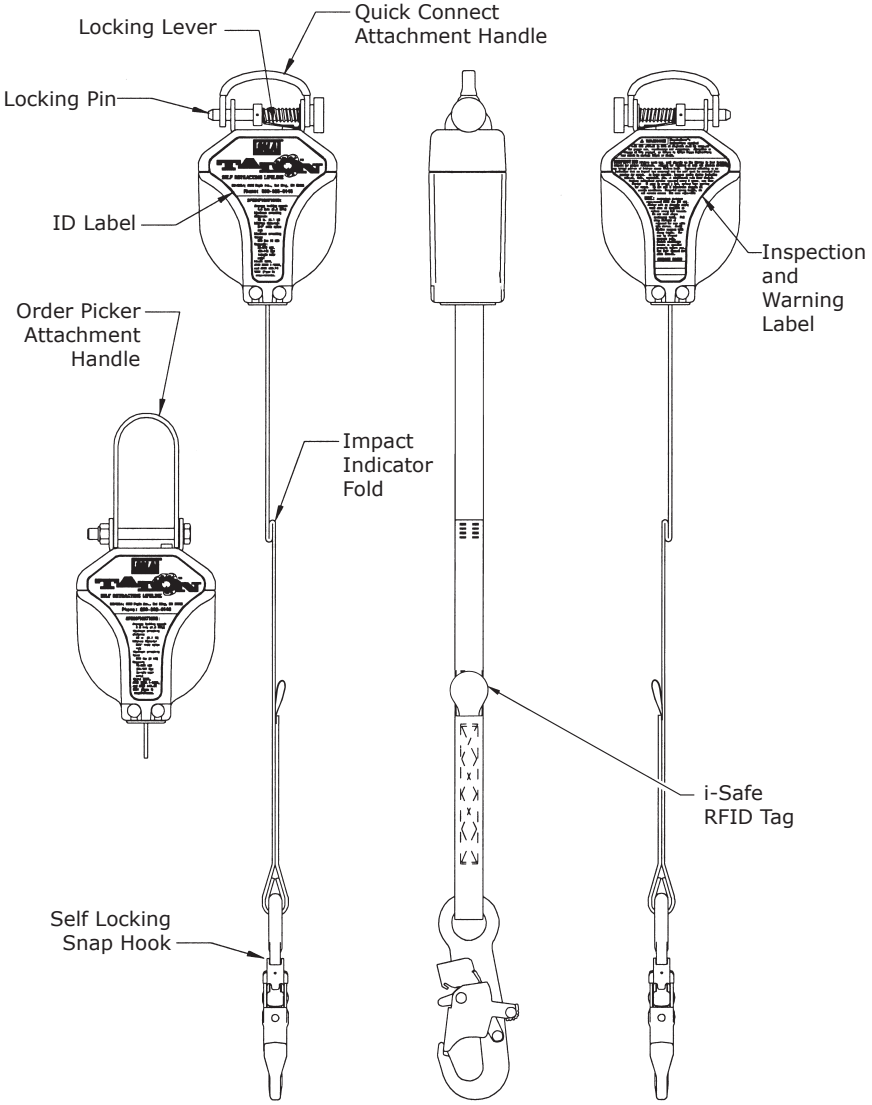
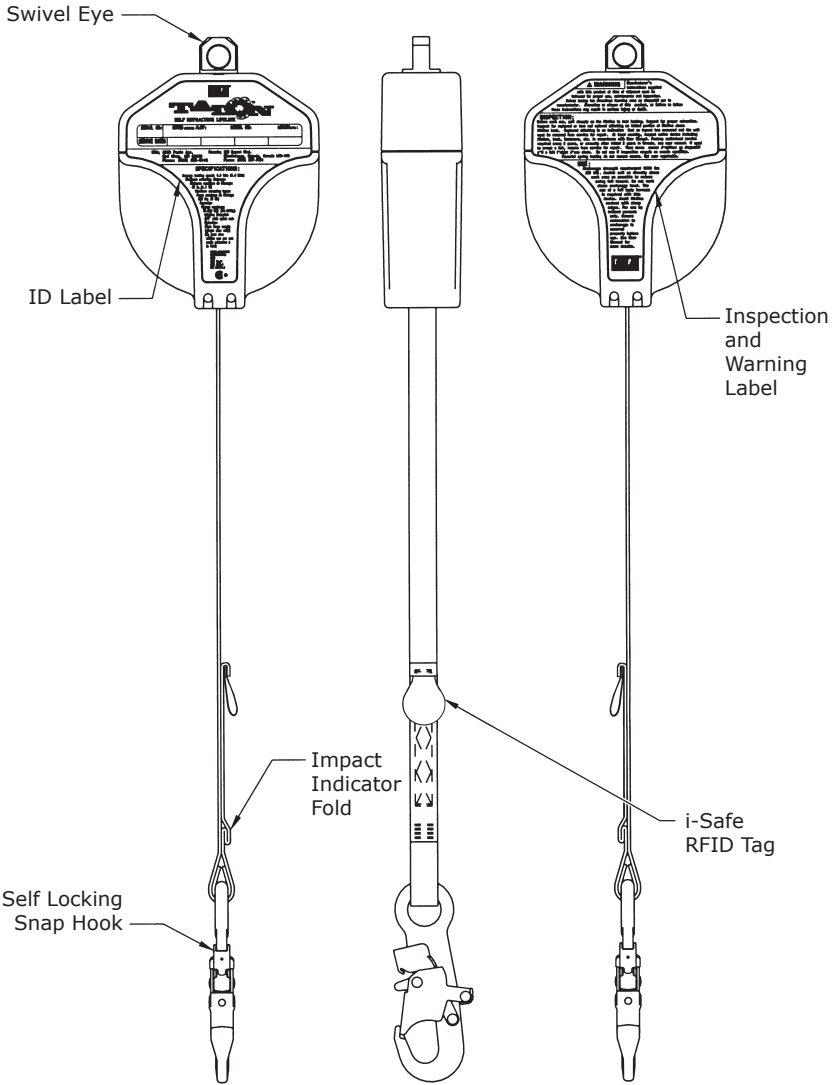

Figure 2 - Talon Self Retracting Lifeline - 16 ft. (4.9 m) Series



WARNING: *This product is part of a personal fall arrest system. These instructions must be provided to the user and rescuer (see section 8 Terminology). The user must read and follow the manufacturer's instructions for each component of the system. The user must read and understand these instructions before using this product. Manufacturer's instructions must be followed for proper use and maintenance of this product. Alteration or misuse of this product, or failure to follow instructions may result in serious injury or death.*

IMPORTANT: *If you have questions about the use, care, or suitability of this equipment for your application contact DBI-SALA.*

IMPORTANT: *Before using this equipment record the product identification information from the ID label in the inspection and maintenance log in section 10.0 of this manual.*

DESCRIPTIONS

TALON 8 FT (2.4 M) SERIES SELF RETRACTING LIFELINE: See Figure 1. Includes quick connect anchorage attachment handle and 8 foot (2.4 m) nylon web lifeline or order picker anchorage attachment handle and 8 foot nylon web lifeline.

TALON 16 FT (4.9 M) SERIES SELF RETRACTING LIFELINE: See Figure 2. Includes swivel eye anchorage attachment and 16 foot (4.9 m) nylon web lifeline.

1.0 APPLICATIONS

1.1 PURPOSE: DBI-SALA self retracting lifelines (SRL's) are components of a personal fall arrest system (PFAS). These SRL's may be used where worker mobility and fall protection are required.

FALL PROTECTION: The SLR is used as part of a complete personal fall arrest system. Personal fall arrest systems typically include a full body harness, anchorage connector, and SRL.

1.2 LIMITATIONS

- D. CAPACITY:** The SRL is designed for use by persons with a combined weight (clothing, tools) of no more than 310 lbs. (141 kg). No more than one person may be connected to the SRL at any time.
- E. LOCKING SPEED:** Use of the SRL in confined spaces, on slowly shifting material (sand or grain), or on a low pitched roof may not allow sufficient lock-up speed to arrest a fall. A clear fall path is required to safely arrest a fall.
- F. NORMAL OPERATION:** Normal operation will allow the full length of the lifeline to extend and retract without hesitation or creating a slack line condition as the worker moves at normal

speeds. If a fall occurs, a speed sensing brake system will activate, stopping the fall and absorbing much of the energy created. If a fall has been arrested, the SRL must be removed from service and inspected. See section 5.0. Sudden or quick movements should be avoided during normal work operation as this may cause the SRL to lock-up.

G. ENVIRONMENTAL HAZARDS: Use of the SRL in hazardous environments may require additional precautions to reduce the possibility of injury to the user or damage to the personal fall arrest system. Hazards may include, but are not limited to; heat, extreme cold, caustic or corrosive chemicals, high voltage power lines, explosive or toxic gases, moving machinery, sharp edges.

H. TRAINING: The SRL is intended to be installed and used by persons trained in its application and use.

1.3 Refer to national standards, including the ANSI Z359 (.1, .2, .3, and .4) family of standards on fall protection, ANSI A10.32 and applicable local, state, and federal (OSHA) requirements governing occupational safety for more information about fall arrest.

2.0 SYSTEM REQUIREMENTS

2.1 COMPATIBILITY OF COMPONENTS: DBI-SALA equipment is designed for use with DBI-SALA approved components and subsystems only. Substitutions or replacements made with non-approved components or subsystems may jeopardize compatibility of equipment and may effect the safety and reliability of the complete system. Personal fall arrest systems must meet applicable local, state, and federal (OSHA) requirements. A full body harness must be used with the Talon SRL.

2.2 COMPATIBILITY OF CONNECTORS: Connectors are considered to be compatible with connecting elements when they have been designed to work together in such a way that their sizes and shapes do not cause their gate mechanisms to inadvertently open regardless of how they become oriented. Contact DBI-SALA if you have any questions about compatibility.

Connectors (hooks, carabiners, and D-rings) must be capable of supporting at least 5,000 lbs. (22.2 kN). Connectors must be compatible with the anchorage or other system components. Do not use equipment that is not compatible. Non-compatible connectors may unintentionally disengage. See Figure 3. Connectors must be compatible in size, shape, and strength. Self locking snap hooks and carabiners are required by ANSI Z359.1 and OSHA.

2.3 MAKING CONNECTIONS: Only use self-locking snap hooks and carabiners with this equipment. Only use connectors that are suitable to each application. Ensure all connections are compatible

Figure 3 - Unintentional Disengagement (Roll-out)

If the connecting element that a snap hook (shown) or carabiner attaches to is undersized or irregular in shape, a situation could occur where the connecting element applies a force to the gate of the snap hook or carabiner. This force may cause the gate (of either a self-locking or a non-locking snap hook) to open, allowing the snap hook or carabiner to disengage from the connecting point.

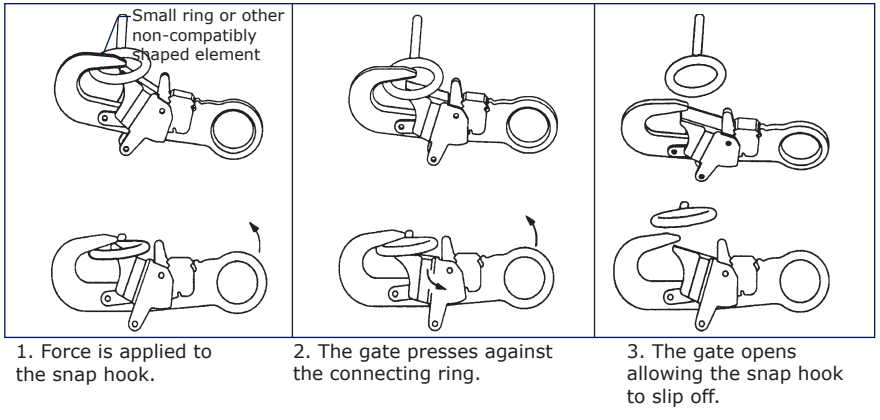

in size, shape and strength. Do not use equipment that is not compatible. Ensure all connectors are fully closed and locked.

DBI-SALA connectors (snap hooks and carabiners) are designed to be used only as specified in each product's user's instructions. See Figure 4 for inappropriate connections. DBI-SALA snap hooks and carabiners should not be connected:

- A. To a D-ring to which another connector is attached.
- B. In a manner that would result in a load on the gate.

NOTE: Large throat opening snap hooks should not be connected to standard size D-rings or similar objects which will result in a load on the gate if the hook or D-ring twists or rotates. Large throat snap hooks are designed for use on fixed structural elements such as rebar or cross members that are not shaped in a way that can capture the gate of the hook.

- C. In a false engagement, where features that protrude from the snap hook or carabiner catch on the anchor and without visual confirmation seems to be fully engaged to the anchor point.
- D. To each other.
- E. Directly to webbing or rope lanyard or tie-back (unless the manufacturer's instructions for both the lanyard and connector specifically allow such a connection).
- F. To any object which is shaped or dimensioned such that the snap hook or carabiner will not close and lock, or that roll-out could occur.

Figure 4 - Inappropriate Connections

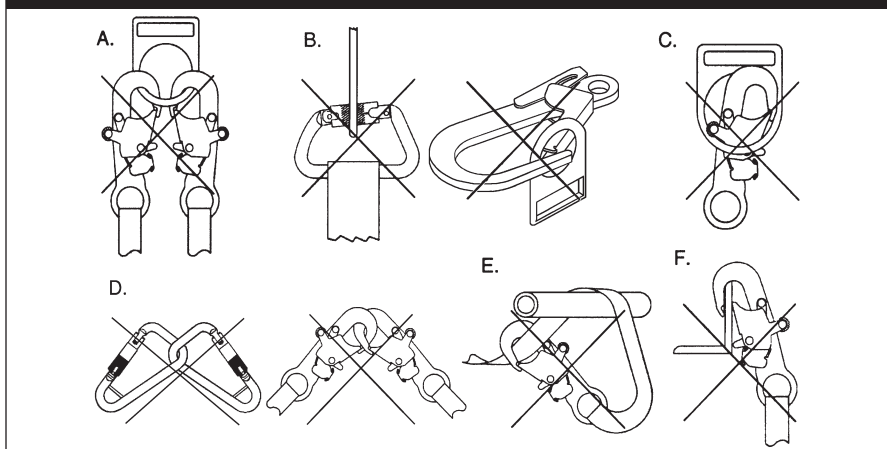

2.4 ANCHORAGE STRENGTH: In accordance with ANSI Z359.1, anchorages selected for a fall arrest systems shall have a strength capable of sustaining static loads applied in the directions permitted by the system of at least: A) 5,000 pounds (22.2 kN) for non-certified anchorages or B) Two times the maximum arresting force for certified anchorages (see section 8 Terminology). When more than one personal fall arrest system is attached to an anchorage, the strengths previously set forth in (A) and (B) shall be multiplied by the number of systems attached to the anchorage.

- **From OSHA 1910.66 and 1926.500:** Anchorages used for attachment of a personal fall arrest system shall be independent of any anchorage being used to support or suspend platforms, and must support at least 5,000 lbs. (22.2 kN) per user attached, or be designed, installed, and used as part of a complete personal fall arrest system which maintains a safety factor of at least two, and is supervised by a qualified person.

2.5 USING THE SRL WITH A HORIZONTAL SYSTEM: The SRL and horizontal system components must be compatible. Horizontal systems must be designed and installed under the supervision of a qualified person (see section 8 Terminology).

3.0 INSTALLATION AND USE

WARNING: Do not alter or intentionally misuse this equipment. Consult DBI-SALA when using this equipment in combination with components or subsystems other than those described in this manual. Some subsystem and component combinations may interfere with the operation of this equipment. Use caution when using this equipment around moving machinery, electrical hazards, chemical hazards, and sharp edges.

WARNING: Consult your doctor if there is reason to doubt your fitness to safely absorb the shock from a fall arrest. Age and fitness can seriously affect your ability to withstand a fall. Pregnant women and minors must not use this equipment.

3.1 BEFORE EACH USE: Inspect the SRL according to section 5.0.

3.2 PLAN your personal fall arrest system before installing and using this equipment. Consider all factors affecting your safety during use of this equipment.

A. ANCHORAGE: Select a rigid anchorage point capable of supporting at least 5,000 lbs. (22.2 kN) See section 2.4. Select an anchorage location that will avoid free fall and swing fall hazards. To prevent an increased free fall distance do not work above the anchorage.

B. FREE FALL: Your personal fall arrest system must be rigged such that the SRL is above your harness attachment element (dorsal D-ring) when in use. Avoid working where your lifeline may cross or tangle with that of another worker. Do not allow the lifeline to pass under your arms or between your feet. Never clamp, knot, or otherwise prevent the lifeline from retracting. Do not allow slack in your lifeline. Do not lengthen the SRL by connecting a lanyard or other component.

C. SWING FALLS: Swing falls occur when the anchorage point is not directly above the point where a fall occurs. The force of striking an object in a swing fall may cause serious injury. In a swing fall, the total vertical fall distance will be greater than if the user had fallen directly below the anchorage point, thus increasing the total free fall distance and the area required to safely arrest the user. The SRL will

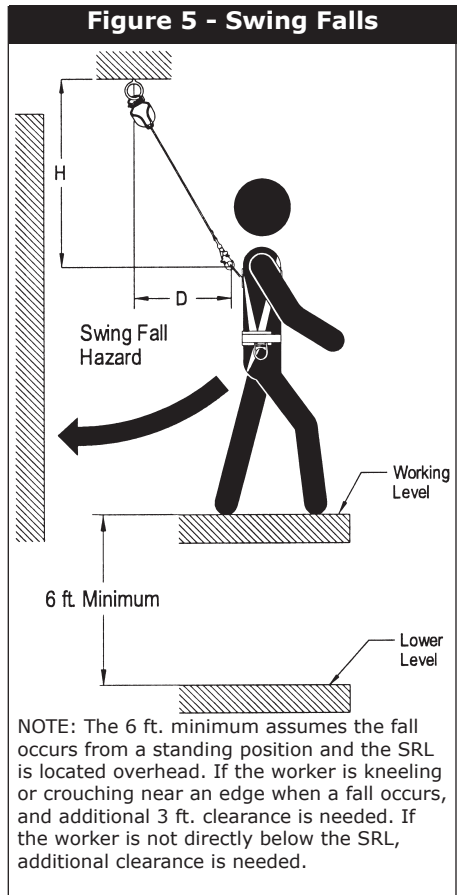
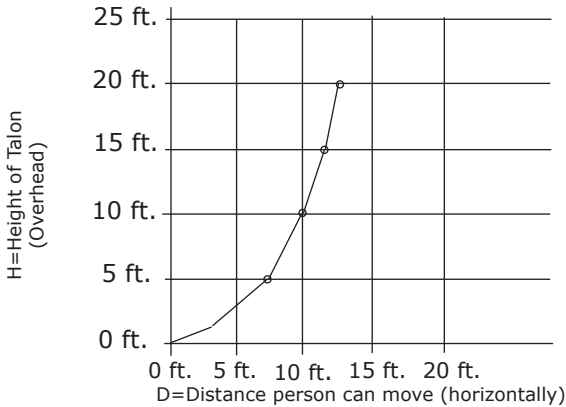

Chart 1
Working Distance From Anchorage



Example: If the worker is 15 feet directly below the SRL.
The recommended work zone is 12 feet in any direction

activate regardless of its orientation relative to the user. The recommended work zone represents the typical acceptable work area for most applications. Review your specific application to determine what the appropriate work zone should be. See Chart 1. Minimize swing falls by working as directly below the anchorage point as possible. Never permit a swing fall if injury could occur. If a swing fall situation exists in your application contact DBI-SALA before proceeding. See Figure 5.

- D. FALL CLEARANCE:** Ensure adequate clearance exists in your fall path to prevent striking an object. A minimum of 6 feet from the working level to the lower level or nearest obstruction is recommended. See Figure 5.
- E. SHARP EDGES:** Avoid working where the lifeline will be in contact with or abrade against unprotected sharp edges. Provide protection for the lifeline when possible. An energy absorbing component can sometimes be added in-line to further protect the worker. Compatibility and total fall distance must be considered if this is done. Contact DBI-SALA before using an in-line energy absorbing component or lanyard with an SRL.
- F. AFTER A FALL:** Equipment which has been subjected to fall arrest forces must be removed from service for inspection. See section 5.
- G. RESCUE:** If a fall occurs, the employer must have a rescue plan and the ability to implement a rescue.

3.3 BODY SUPPORT: A full body harness must be used with the SRL. For fall arrest applications connect to the dorsal D-ring on your harness.

Figure 6 - Connecting to the Anchorage

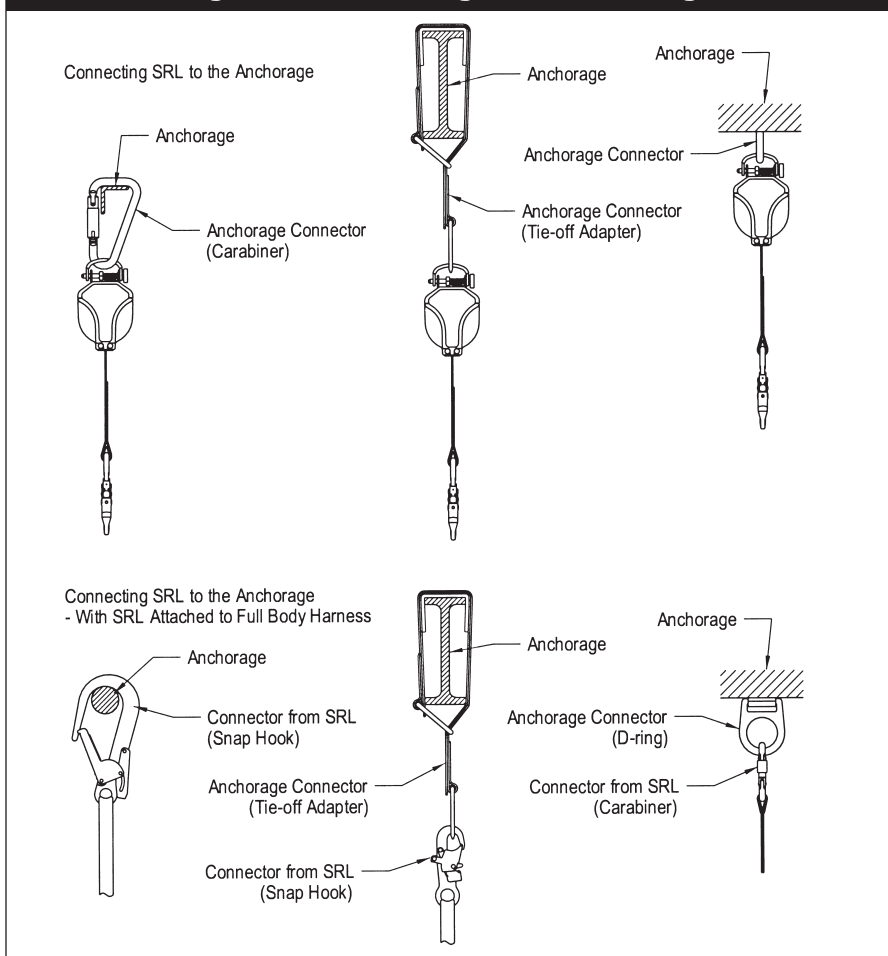

3.4 CONNECTING TO THE ANCHORAGE: When using a hook or carabiner to attach to the anchorage, ensure roll-out cannot occur. See section 2.3. Do not use a hook or carabiner that will not completely close over the anchorage or anchorage connector. See Figure 6. Follow the manufacturer's instructions supplied with each system component.

- A. QUICK-CONNECT ATTACHMENT HANDLE:** See Figure 7. To open the quick-connect attachment handle, depress the locking lever on top of the SRL. Pull the locking pin out to release the handle. Swing the handle up to open. Place the handle around the anchorage or anchorage connector. Swing the handle down and realign the holes. Push the locking pin through the holes.

WARNING: Ensure the locking pin fully engages the handle and the locking lever is in the locked position.

Figure 7 - Using the Attachment Handles and Swivel Eye

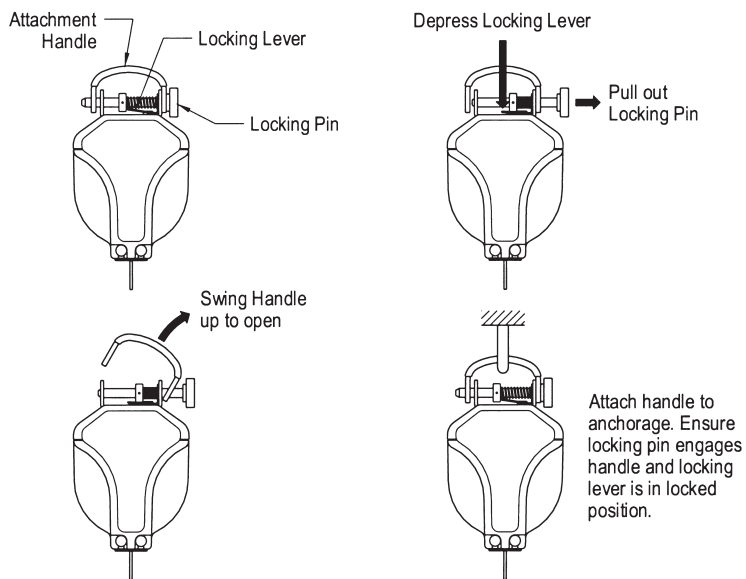

Quick Connect Attachment Handle

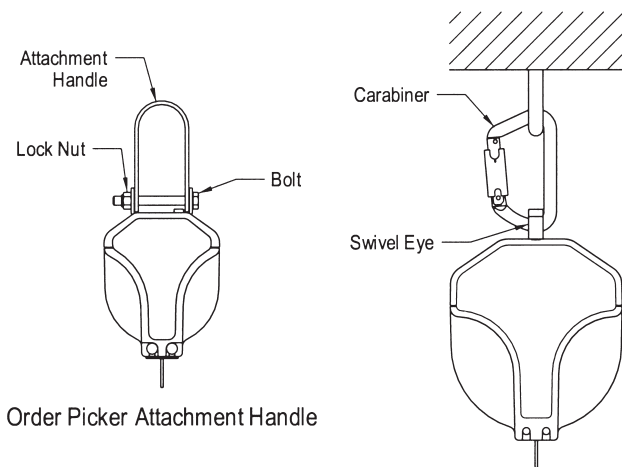

Order Picker Attachment Handle

Swivel Eye Anchorage Attachment

- B. ORDER PICKER ATTACHMENT HANDLE:** See Figure 7. Open the order picker attachment handle by removing the bolt and lock nut. Place the handle around the anchorage or anchorage connector. Reinstall the bolt and lock nut. Do not over tighten.

- C. **SWIVEL EYE:** See Figure 7. Attach the SRL to the anchorage or anchorage connector by inserting a carabiner through the swivel eye and around the anchorage or anchorage connector [16 ft. (4.9 m) series only].

3.5 ATTACHING THE SRL TO A FULL BODY HARNESS:

For models including a quick-connect attachment handle only, and to be used with DBI-SALA full body harnesses only. See Figure 8. To attach the SRL directly to a full body harness, pass the quick-connect attachment handle through the same loops as the existing D-ring or connector. Connect the SRL hook or carabiner to a suitable anchorage.



- 3.6 **USING THE SRL:** Connect the SRL to a suitable anchorage. Connect the SRL hook or carabiner to the appropriate connector on your full body harness. Ensure hook or carabiner is closed and locked onto the harness connector.

NOTE: Do not use the following DBI-SALA hooks and carabiners to connect to your full body harness: 2000108, 2007153, and 9510057. See Figure 9.

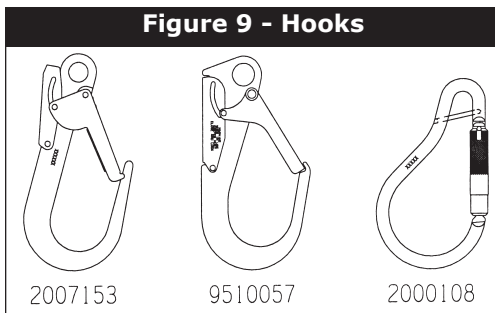

When connected to the SRL the worker is free to move about within the recommended working

area. The lifeline should extend and retract without hesitation or creating a slack line condition as speeds. If a fall occurs the SRL will lock and arrest the fall. When disconnecting from the SRL keep the lifeline under control as it recoils back into the device. A tag line may be required to extend or retract the lifeline.

- 3.7 **IMPACT INDICATOR:** See Figure 10. The SRL incorporates an impact indicator in the lifeline. The lifeline web is folded over and stitched with red thread. The stitched fold will pull out at approximately 450 lbs. (204 kg) If the red stitching is intact the SRL has not been impacted. If the red stitching is broken and

the fold torn apart, the SRL has been impacted and must be removed from service and returned to an authorized service center for repair.

4.0 TRAINING

- 4.1** It is the responsibility of all users of this equipment to understand these instructions, and to be trained in the correct installation, use, and maintenance of this equipment. These individuals must be aware of the consequences of improper installation or use of this equipment. This user manual is not a substitute for a comprehensive training program. Training must be provided on a periodic basis to ensure proficiency of the users.

WARNING: Training must be conducted without exposing the trainee to a fall hazard. Training must be repeated on a periodic basis.

5.0 INSPECTION

- 5.1** The i-Safe™ RFID tag on this SRL can be used in conjunction with the i-Safe handheld reading device and the web based portal to simplify inspection and inventory control and provide records for your fall protection equipment (see Fig. 11).

5.2 FREQUENCY:

- **Before Each Use:** OSHA 1910.66, OSHA 1926.502 and ANSI Z359.1 requires an inspection of equipment before each use. See sections 5.2, 5.3, and 5.4 for inspection guidelines.
- **Annually:** ANSI Z359.1 requires a formal inspection of the SRL be completed by a competent person other than the user. More frequent inspections by a competent person may be required based on the nature and severity of workplace conditions affecting the equipment and the modes of use and

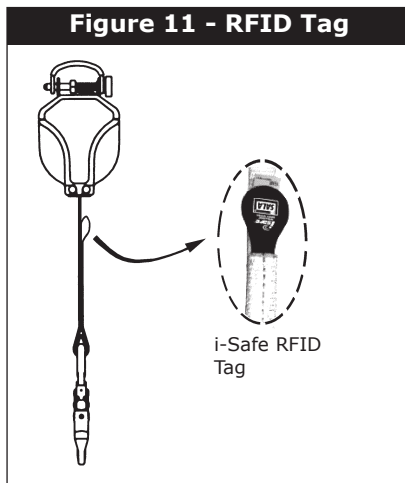
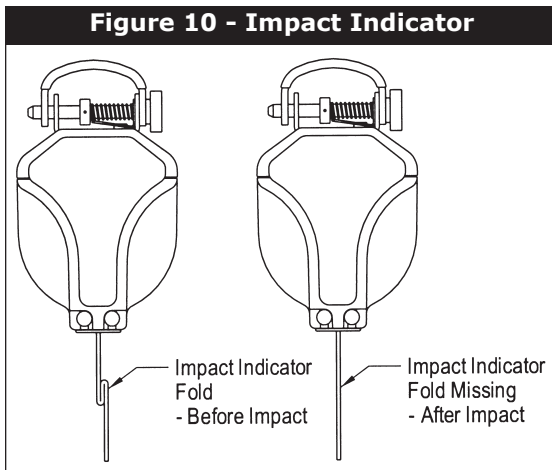

exposure time of the equipment. See sections, 5.3, and 5.4 for inspection guidelines. Record results in the inspection and maintenance log in section 10.0, or use the i-Safe™ inspection web portal to maintain your inspection records. If you are a first-time user, contact a Customer Service representative in the US at 800-328-6146 or in Canada at 800-387-7484 or if you have already registered, go to: www.capitalsafety.com/isafe.html. Follow instructions provided with your i-Safe handheld reader or on the web portal to transfer your data to your web log.

***NOTE:** In Canada, CSA requires SRLs to be serviced within two years of the manufactured date, and annually thereafter.

- **After a Fall Arrest:** Inspect impact indicator according to section 5.3, and the entire SRL according to sections 5.4 and 5.5.

5.3 IMPACT INDICATOR: To inspect the impact indicator, find the fold in the lifeline stitched with red thread, as shown in Figure 10. If the red stitching is broken and the fold torn apart, the SRL has been impacted and must be removed from service and returned to an authorized service center for repair. Do not re-stitch the fold.

WARNING: *If the SRL has been subjected to fall arrest or impact forces it must be removed from service and returned to an authorized service center for repair.*

5.4 INSPECTION STEPS:

- Step 1.** Check for loose screws and bent or damaged parts.
- Step 2.** Check the housing for distortion, cracks, or other damage. Ensure the anchorage point is not damaged or distorted.
- Step 3.** The lifeline must fully extend and retract smoothly with no hesitation or slack line condition.
- Step 4.** Ensure the device locks when the lifeline is pulled sharply. Lock-up should be positive, with no slipping.
- Step 5.** All labels must be present and fully legible.
- Step 6.** Check for corrosion on the entire unit.
- Step 7.** Check the lifeline for cuts, burns, chemical damage, or severely abraded areas. The lifeline must not be damaged.
- Step 8.** Check the connecting hooks or carabiners for damage, distortion, or corrosion, and working condition.
- Step 9.** Inspect each component of the personal fall arrest system according to manufacturer's instructions.

Step 10. Record the inspection results in the inspection and maintenance log in section 10.0 or using the I-safe web portal.

5.5 If the inspection reveals an unsafe or defective condition, remove the SRL from service and contact an authorized service center for repair.

NOTE: Only DBI-SALA or parties authorized in writing may make repairs to this equipment.

6.0 MAINTENANCE, SERVICING, AND STORAGE

6.1 MAINTENANCE:

- A. HOUSING:** Periodically clean the exterior of the SRL with water and a mild detergent. Position the SRL so water can drain out. Clean the labels as required.
- B. LIFELINE:** Clean the lifeline with water and a mild detergent. Rinse and thoroughly air dry. Do not force dry with heat. An excessive build-up of dirt or other contaminants may prevent the lifeline from fully retracting, causing a potential free fall hazard. Return the SRL to an authorized service center for lifeline replacement if necessary.
- C. PERSONAL FALL ARREST SYSTEM COMPONENTS:** Clean and store associated system components according to manufacturer's instructions.

6.2 SERVICING: Do not disassemble the SRL. Do not lubricate any part of the SRL. Additional maintenance and servicing must be performed by an authorized service center. A return authorization number must be issued by DBI-SALA. See section 5.2 for servicing frequency.

6.3 STORAGE: Store the SRL in a cool, dry, and clean environment, out of direct sunlight. Avoid storing the SRL in areas where chemical vapors exist. Thoroughly inspect the SRL after extended storage.

7.0 SPECIFICATIONS

7.1 PERFORMANCE SPECIFICATIONS:

- **Capacity (All Models):** 75 - 310 lbs. (34 - 141 kg), one user only
- **Working Range, 8 Foot Models:** 2.5 ft. - 8 ft (.8 m - 2.4 m)
- **Working Range, 16 Foot Models:** 1.5 ft. - 16 ft (.5 m - 4.9 m)
- **Maximum Arresting Force (All Models):** 900 lbs. (408 kg) when tested in accordance with ANSI Z359.1.
- **Average Locking Speed (All Models):** 4.5 ft./sec. (1.4 m / sec.)
- **Maximum Arresting Distance (All Models):** 42 in. (1 m)

7.2 PHYSICAL SPECIFICATIONS:

8 FOOT MODELS:

- **Overall Dimensions, Quick-Connect Attachment Handle Models (LxWxH):** 6.7 x 3.9 x 2.2 in. (17 cm x 10 cm x 6 cm)
- **Overall Dimensions, Order Picker Attachment Handle Models (LxWxH):** 8.9 x 3.9 x 2.2 in. (23 cm x 10 cm x 6 cm)

16 FOOT MODELS:

Overall Dimensions (LxWxH): 7.9 x 5.9 x 2.4 in. (20 cm x 15 cm x 6 cm)

ALL MODELS:

Materials:

Housing: Nylon

Cable Drum: Glass filled nylon

Internal Components: Steel/Aluminum

Lifeline: 3/4 inch nylon web

7.3 PATENTS AND REQUIREMENTS:

- Patents Pending
- Meets ANSI Z359.1 and OSHA requirements

8.0 TERMINOLOGY

AUTHORIZED PERSON: A person assigned by the employer to perform duties at a location where the person will be exposed to a fall hazard (otherwise referred to as "user" for the purpose of these instructions).

RESCUER: Person or persons other than the rescue subject acting to perform an assisted rescue by operation of a rescue system.

CERTIFIED ANCHORAGE: An anchorage for fall arrest, positioning, restraint, or rescue systems that a qualified person certifies to be capable of supporting the potential fall forces that could be encountered during a fall or that meet the criteria for a certified anchorage prescribed in this standard.

QUALIFIED PERSON: A person with a recognized degree or professional certificate and with extensive knowledge, training, and experience in the fall protection and rescue field who is capable of designing, analyzing, evaluating and specifying fall protection and rescue systems to the extent required by this standard.

COMPETENT PERSON: One who is capable of identifying existing and predictable hazards in the surroundings or working conditions which are unsanitary, hazardous, or dangerous to employees, and who has authorization to take prompt corrective measures to eliminate them.

9.0 LABELING

9.1 The following labels must be present and fully legible:

8 Foot Series SRL:

TATON™
SELF RETRACTING LIFELINE 9503200 REV A

MFRD (YR/MO): LOT: MODEL NO: LENGTH (FT): SERIAL NO: **XXXXXX**

www.capitalsafety.com
Ph: (800) 328-6146

INSPECTION LOG		SERVICE DATE	
DATE	INITIALS	DATE	INITIALS

SPECIFICATIONS:
Capacity:
75-310 lbs. (34-141 kg).
Maximum arrest force:
900 lbs (4 kN).
Maximum arrest distance:
42 in (1.1 M).
Lifeline material:
3/4 in x .1 in
nylon web
Meets OSHA,
ANSI Z359.1 and
ANSI A10.32-2004.

SALA™
MADE IN U.S.A.
DO NOT REMOVE
THIS LABEL

ANSI ID Label

WARNING Read instructions before use. Manufacturer's instructions supplied with this product at time of shipment must be followed for proper use, maintenance and inspection. Alteration or misuse of this product, or failure to follow instructions may result in serious injury or death.

INSPECTION: Before each use, and at least monthly, inspect device in accordance with user manual including locking function (pull sharply to test), retraction function, lifeline condition, function and condition of connectors, housing and fasteners, legibility of labels, and for any evidence of defects, damage or missing parts. Inspect for ruptured or torn red colored stitching on foisted portion of lifeline above lifeline hook. Ruptured stitching is an indication that an impact has occurred and the unit must be removed from service. Inspection by a competent person is required at least annually, see user manual. If used to arrest a fall, remove from service for inspection. Do not use if inspection reveals an unsafe condition.

USE: Anchorage strength requirement 5000 lbs (22 kN). Anchor unit as directly above work area as possible to reduce swing fall hazard. Do not work above anchorage level. Full body harness is required for use with this device. Avoid lifeline contact with sharp edges. For use by trained persons only. See user manual for more details. Powerful spring inside; do not remove cover. Not user repairable.

DO NOT REMOVE THIS LABEL
9503235 Rev. A

ANSI Warning/Inspection Label

TATON™
SELF RETRACTING LIFELINE

Model No. (date): Lot: Model No. N° du modèle: Length (ft) Longueur (p): Serial No. N° de série: **XXXXXX**

www.capitalsafety.com
USA: 800-328-6146
CANADA: 800-367-7494

SPECIFICATIONS:
Capacity: 34-141 kg (75-310 lbs) (single user only)
Maximum Arrest Force: 4 kN (900 lbs)
Maximum Arrest Distance: 1.1 m (34 ft)
Lifeline: 19 mm (3/4 in) x 2.5 mm (.1 in) nylon web

CARACTÉRISTIQUES:
Capacité: 34 à 141 kg (75 à 310 lbs) (un seul utilisateur)
Force d'arrêt maximum: 4 kN (900 lb)
Distance d'arrêt maximum: 1,1 m (34 po)
Corde d'assurance: simple en nylon 19 mm (3/4 po) x 2,5 mm (.1 po)

SERVICE DATE / DATE DE REPARATION	NEXT SERVICE / PROGRAM ENTRETIEN

SALA™
MADE IN USA / Fabriqué aux USA

2269.22, TYPE 1 (SRL)
9503154 Rev. A

CSA ID Label

WARNING Manufacturer's instructions supplied with this product at time of shipment must be followed for proper use, maintenance and inspection. Failure to follow instructions may result in serious injury or death. This device shall be removed from service when subjected to a fall.

AVERTISSEMENT On doit observer les instructions du fabricant fournies avec ce produit pour bien l'utiliser. Fautes de respect des instructions peuvent occasionner des blessures graves, voire mortelles. On doit mettre ce dispositif hors de service lorsqu'il a servi à l'arrêt d'une chute.

INSPECTION: Before each use, inspect in accordance with the User Manual including locking function (pull sharply to test), retraction, lifeline condition, function and condition of connector, housing and fasteners, legibility of labels, and any evidence of defects, damage or missing parts. Inspection by a competent person required at least annually. See User Manual. Do not use if inspection reveals an unsafe condition.

INSPECTION: Avant chaque utilisation, inspectez conformément au guide de l'utilisateur, notamment la fonction de blocage (tirer d'un coup sec pour tester), rétractation de la corde d'assurance, le fonctionnement et l'état du connecteur, du logement et des fasteners, la lisibilité des étiquettes et tout autre signe de défaut, de dommage ou de pièce manquante. Le dispositif doit être inspecté par une personne compétente au moins une fois par année. Voir le guide de l'utilisateur. Ne pas utiliser si l'inspection révèle une condition dangereuse.

USE: Anchorage strength requirement 22 kN (5000 lb). Anchor unit as directly above work area as possible to reduce swing fall hazard. Do not work above anchorage level. Full body harness required for use with this device. Avoid lifeline contact with sharp edges. For use by trained persons only. See User Manual for additional information. Powerful spring inside; do not remove cover. Not user repairable.

UTILISATION: L'ancrage doit avoir une résistance de 22kN (5000 lb). L'ancrage doit être aussi directement que possible au-dessus de la zone de travail pour réduire le risque de chute par balancement. On ne doit pas travailler au-dessus du niveau de l'ancrage. On doit porter un harnais de sécurité avec ce dispositif. Faire en sorte que la corde d'assurance n'entre pas en contact avec des arêtes vives. Doit être utilisé seulement par des personnes formées. Voir le guide de l'utilisateur pour de plus amples renseignements. Ressort puissant à l'intérieur; ne pas enlever le couvercle. Non réparable par l'utilisateur.

9503153 Rev. A

CSA Warning/Inspection Label

16 Foot Series SRL:

TALON
SELF RETRACTING LIFELINE

MFRD (YR/MO):	LOT:	MODEL NO.:	LENGTH (FT):	SERIAL NO.:
---------------	------	------------	--------------	-------------

INSPECTION LOG				
DATE	INITIALS	DATE	INITIALS	

www.capitalsafety.com
Ph: (800) 329-8146

SPECIFICATIONS:
Capacity: 75-110 lbs (34-14.1 kg).
Maximum arrest force: 600 lbs (4 kN).
Maximum arrest distance: 42 in (1.1 m).
Lifeline material: 3/4 in x 1 in nylon web.
Meets OSHA, ANSI Z359.1 and ANSI A10.32-2004.

SERVICE DATE:

DO NOT REMOVE THIS LABEL
890329 Rev. A

ANSI ID Label

⚠ WARNING

Read instructions before use. Manufacturer's instructions supplied with this product at time of shipment must be followed for proper use, maintenance and inspection. Alteration or misuse of this product, or failure to follow instructions may result in serious injury or death.

INSPECTION: Before each use, and at least monthly, inspect device in accordance with user manual including locking function (shock to test), retraction function, lifeline condition, function and condition of connectors, housing and fasteners, legibility of labels, and for any evidence of defects, damage or missing parts. Inspect for ruptured or torn red colored stitching on folded portion of lifeline above lifeline hook. Ruptured stitching is an indication that an impact has occurred and the unit must be removed from service. Inspection by a competent person is required at least annually. See user manual. If used to arrest a fall, remove from service for inspection. Do not use if inspection revealed an unsafe condition.

USE: Anchorage strength requirement 5000 lbs (22 kN). Anchor unit as directly above work area as possible to reduce swing fall hazard. Do not work above anchorage level. Full body harness is required for use with this device. Avoid lifeline contact with sharp edges. For use by trained persons only. See user manual for more details. Powerful spring inside: do not remove cover. Not user repairable.

DO NOT REMOVE THIS LABEL
890329 Rev. A

ANSI Warning/Inspection Label

TALON
SELF RETRACTING LIFELINE

Mfr (year): (date)	Lot:	Model No: N° de modèle:	Length (ft): Longueur (m):	Serial No: N° de série:
-----------------------	------	----------------------------	-------------------------------	----------------------------

SPECIFICATIONS:
Capacity: 34-41 kg (75-110 lb) (single user only)
Maximum Arrest Force: 4 kN (900 lb)
Maximum Arrest Distance: 1.1 m (34 in)
Lifeline: 3/4 in x 1 in (2.5 mm x 1 in) nylon web

CARACTÉRISTIQUES:
Capacité: 75 à 110 LBS (34 à 14,1 kg) (un seul utilisateur)
Force d'arrêt maximum: 4 kN (900 lb)
Distance d'arrêt maximum: 1,1 m (34 po)
Corde de sécurité: tresse en nylon (2,5 mm x 1 po)

SERVICE DATE / DATE DE RÉPARATION

NEXT SERVICE / PROCHAIN ENTRETIEN

www.capitalsafety.com
USA: 800-329-8146
CANADA: 800-387-7484

Made in USA / Fabriqué aux USA

CSA: 2582.2-1 (R12)
890183 Rev. A

CSA ID Label

⚠ WARNING

Manufacturer's instructions supplied with this product at time of shipment must be followed for proper use, maintenance and inspection. Failure to follow instructions may result in serious injury or death. This device shall be removed from service when the impact indicator is displayed.

⚠ AVERTISSEMENT
On doit observer les instructions et l'étiquette imprimée sur le produit pour bien l'utiliser, l'entretenir et l'inspecter. Négliger d'observer les instructions peut occasionner de blessures graves, voire mortelles. Ce dispositif doit être retiré de service dès qu'un indicateur d'impact est affiché.

INSPECTION: Before each use, inspect in accordance with the User Manual including locking function (shock to test), retraction, housing and condition of connector, housing and fasteners, legibility of labels, and any evidence of defects, damage or missing parts. Inspect for ruptured or torn red colored stitching on folded portion of lifeline above lifeline hook. Ruptured stitching is an indication that an impact has occurred and the unit must be removed from service. Inspection by a competent person is required at least annually. See User Manual. Do not use if inspection reveals an unsafe condition.

UTILISATION: L'usage doit être effectué en conformité avec le manuel d'utilisateur, notamment la fonction de blocage (test d'un choc pour tester), l'entraînement et le fil de la corde de sécurité, le fonctionnement et l'état du connecteur, du logement et des fasteners. Inspectez soigneusement la fonction et l'état de l'ensemble du matériel, du logement et des fasteners, de toute couture ou de toute déchirure de la corde de sécurité. Vérifiez si les coutures ou coutures rouges sont fissurées ou déchirées sur la partie repliée de la corde d'assurance au-dessus de l'anneau de la corde d'assurance. Si des coutures ou coutures rouges sont fissurées ou déchirées, cela signifie qu'un impact a pu se produire et que le dispositif doit être retiré de service. Recherchez toute trace de rupture ou de déchirement des coutures de couleur rouge des parties pliables des lignes de vie au-dessus des dispositifs de maintien. Ne l'utilisez pas si une inspection révèle une indication qu'elle n'est pas sûre. Voir le manuel de l'utilisateur. Ne pas utiliser l'appareil s'il est dans un état dangereux.

USE: Anchorage strength requirement 22,000 lbs (10,000 kg). Anchor unit as directly above work area as possible to reduce swing fall hazard. Do not work above anchorage level. Full body harness is required for use with this device. Avoid lifeline contact with sharp edges. For use by trained persons only. See user manual for more details. Powerful spring inside: do not remove cover. Not user repairable.

DO NOT REMOVE THIS LABEL
890183 Rev. A

CSA Warning/Inspection Label

This product is i-Safe enabled and contains an electronic tag that can be read by compatible readers - providing inspection logs, inventory management and safety information.

Ce produit est validé dans i-Safe et contient une étiquette d'identification électronique qui peut être lue par des lecteurs compatibles - en fournissant des registres d'inspection, de l'information sur la gestion des stocks et d'autre information relative à la protection.

890313 Rev. B

i-safe RFID Label

10.0 INSPECTION AND MAINTENANCE LOG

SERIAL NUMBER: _____

MODEL NUMBER: _____

DATE PURCHASED: _____

INSPECTION DATE	INSPECTION ITEMS NOTED	CORRECTIVE ACTION	MAINTENANCE PERFORMED
Approved By:			
Approved By:			
Approved By:			
Approved By:			
Approved By:			
Approved By:			
Approved By:			
Approved By:			
Approved By:			
Approved By:			
Approved By:			
Approved By:			
Approved By:			
Approved By:			

10.0 RELEVÉ D'INSPECTION ET D'ENTRETIEN

NUMÉRO DE SÉRIE: _____

NUMÉRO DE MODÈL: _____

DATE D'ACHAT: _____

DATE D'INSPECTION	OBSERVATIONS	MESURE CORRECTIVE	ENTRETIEN EFFECTUÉ
Approuvé par :			
Approuvé par :			
Approuvé par :			
Approuvé par :			
Approuvé par :			
Approuvé par :			
Approuvé par :			
Approuvé par :			
Approuvé par :			
Approuvé par :			
Approuvé par :			
Approuvé par :			
Approuvé par :			
Approuvé par :			
Approuvé par :			
Approuvé par :			
Approuvé par :			
Approuvé par :			
Approuvé par :			

10.0 HOJA DE REGISTRO DE INSPECCIONES Y MANTENIMIENTOS

FECHA DE FABRICACIÓN: _____

NÚMERO DE MODELO: _____

FECHA DE ADQUISICIÓN _____

FECHA DE INSPECCIÓN	OBSERVACIONES	MEDIDAS CORRECTIVAS	MANTENIMIENTO REALIZADO
Aprobada por:			
Aprobada por:			
Aprobada por:			
Aprobada por:			
Aprobada por:			
Aprobada por:			
Aprobada por:			
Aprobada por:			
Aprobada por:			
Aprobada por:			
Aprobada por:			
Aprobada por:			
Aprobada por:			

This instruction applies to the following models:

3101000	3101014
3101001	3101015
3101002	3101016
3101003	3101017
3101004	3101018
3101005	3101019
3101006	3101021
3101007	3101050
3101008	3101051
3101009	3101052
3101010	3101053
3101011	3101054
3101012	3101055
3101013	

Additional model numbers may appear on the next printing.

WARRANTY

Self Retracting Lifelines offered by DBI-SALA are warranted against factory defects in workmanship and materials for a period of two years from date of purchase. Upon notice in writing, DBI-SALA will promptly repair or replace all defective items. DBI-SALA reserves the right to have any defective item returned to its plant for inspection before making a repair or replacement. Warranty does not cover equipment damages resulting from abuse, damage in transit, or other damage beyond the control of DBI-SALA. This warranty applies only to the original purchaser and is the only one applicable to our products, and is in lieu of all other warranties, expressed or implied.

GARANTIE

Les cordes d'assurance auto-rétractables offertes par DBI-SALA sont garanties contre tout défaut de l'usine en matière de main-d'œuvre et de matériaux pendant une période de deux ans à compter de la date d'achat. Sur réception d'une note écrite, DBI-SALA s'engage à réparer ou remplacer rapidement les articles défectueux. DBI-SALA réserve le droit de faire inspecter à son usine tout item défectueux qui lui a été retourné avant de le réparer ou de le remplacer. La garantie ne couvre pas les dommages à l'équipement au-delà du contrôle de DBI-SALA. Cette garantie s'applique seulement à l'acheteur original et est la seule applicable à nos produits et remplace toute autre garantie, explicite ou implicite.

GARANTÍA

Las cuerdas de salvamento autorretráctiles ofrecidas por DBI-SALA están garantizadas por cualquier defecto de fábrica, en cuanto a mano de obra y materiales, durante un período de dos años desde la fecha de compra. Previo aviso por escrito, DBI-SALA reparará o reemplazará de inmediato cualquier pieza defectuosa. DBI-SALA se reserva el derecho de decidir si se devuelve a la planta cualquier elemento defectuoso para su inspección, antes de llevar a cabo su reparación o sustitución. Esta garantía no cubre los daños al equipo ocasionados por el abuso, daño en tránsito u otros daños ajenos al control de DBI-SALA. Esta garantía sólo se aplica al comprador original y, únicamente, a nuestros productos, en sustitución de todas las demás garantías expresas o implícitas.



USA

3833 SALA Way
Red Wing, MN 55066-5005
Toll Free: 800-328-6146
Phone: (651) 388-8282
Fax: (651) 388-5065
Email: solutions@capitalsafety.com
www.capitalsafety.com

Canada

260 Export Boulevard
Mississauga, Ontario L5S 1Y9
Toll Free: 800-387-7484
Phone: (905) 795-9333
Fax: (905) 795-8777
Email: solutions@capitalsafety.com
www.capitalsafety.com

This instruction manual is available for download at www.capitalsafety.com.

Vous pouvez télécharger ce manuel à l'adresse suivante: www.capitalsafety.com

Este manual de instrucciones está disponible para ser descargado en www.capitalsafety.com.



Certificate No. FM 39709

Form: 5911858
Rev: H